

SERIE 6500 "DELFIN"

CORREDERA DE 60MM. FRIA

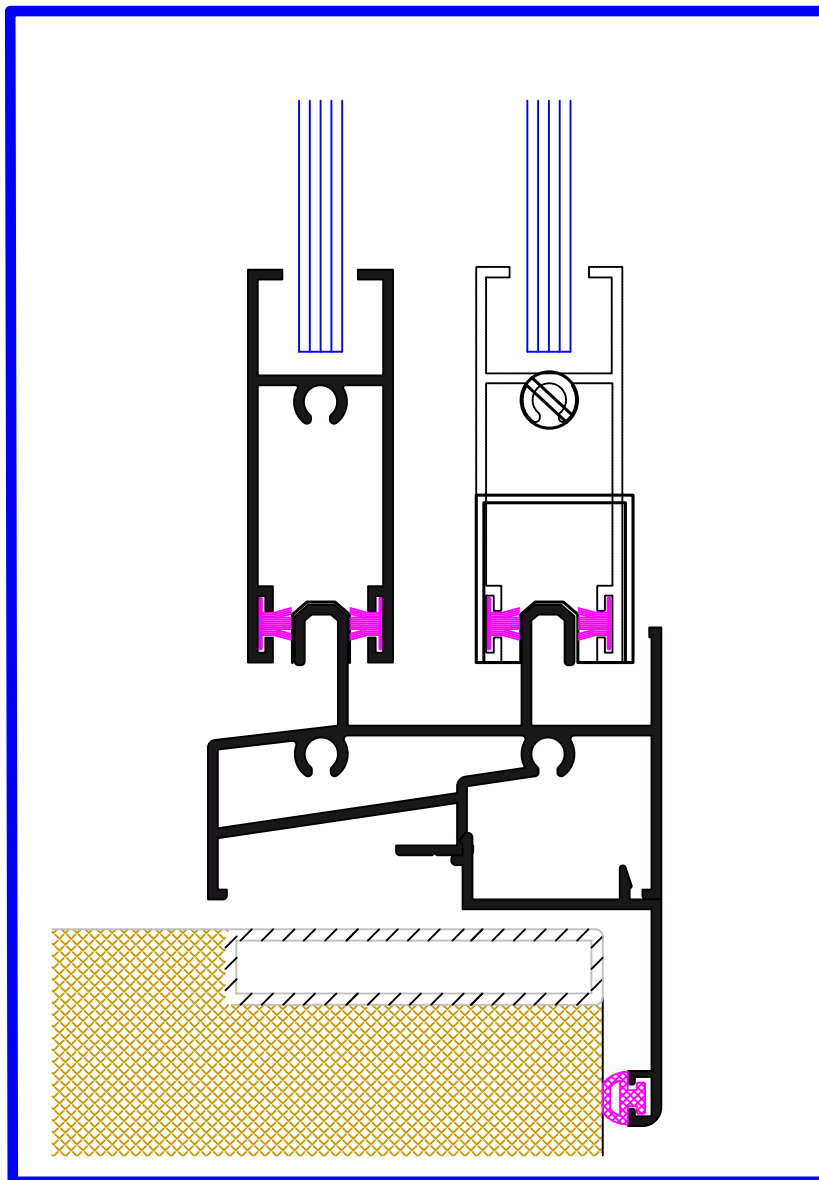

- ◆ Sistema de corredera económico, sencillo montaje y elevadas prestaciones.
- ◆ Sistema de gran versatilidad en sus soluciones constructivas, posibilitando que todos los ensambles de cercos, hojas en recto y a inglete, son combinables indistintamente.
- ◆ Altura de galce de cristal de 14mm. y grosores de hasta de 18 mm.



SERIE 6500 "DELFIN"

RESULTADO DE ENSAYOS

 N° INFORME: 21665. Hoja 21 de 25

RESUMEN DE RESULTADOS

PERMEABILIDAD AL AIRE	CLASE 3
ESTANQUIDAD AL AGUA	CLASE 3A
RESISTENCIA A LA CARGA DE VIENTO	CLASE B1

 Cliente: SIMER, S.A.
Ventana Ref.: «SERIE 6500»

(1.800x2.280, 2hojas+cajón, a testa)

 N° INFORME: 25291. Hoja 21 de 25

RESUMEN DE RESULTADOS

PERMEABILIDAD AL AIRE	CLASE 2
ESTANQUIDAD AL AGUA	CLASE 3A
RESISTENCIA A LA CARGA DE VIENTO	CLASE B1

 Cliente: SIMER, S.A.
Ventana Ref.: «SERIE 6500 PERIMETRAL»

(1.800x2.280, 2hojas+cajón, en inglete)

CERCOS

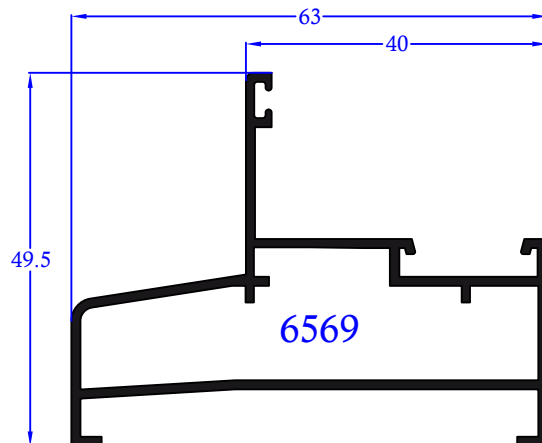
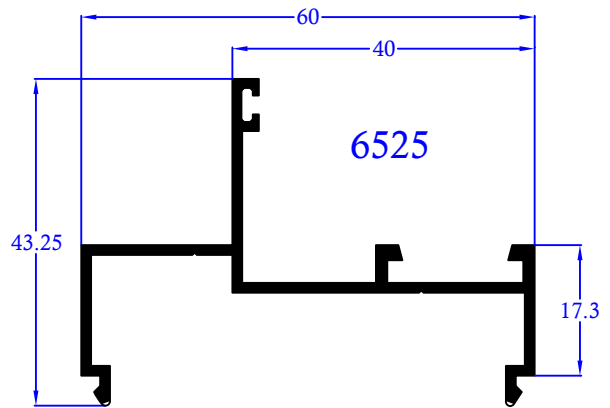
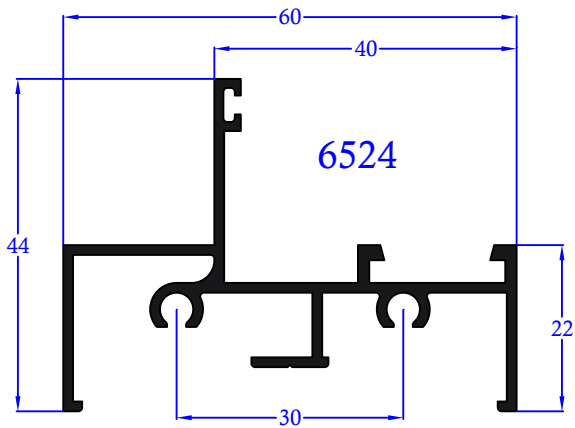
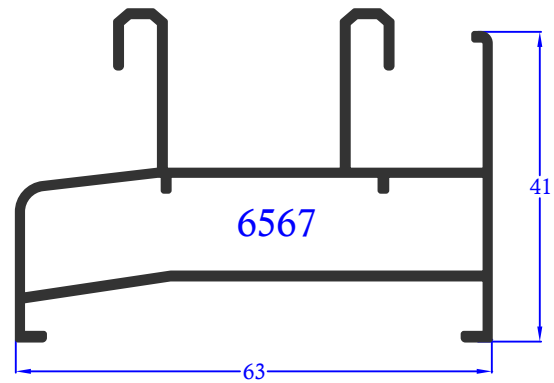
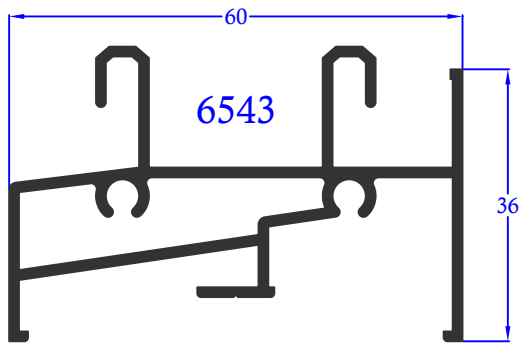
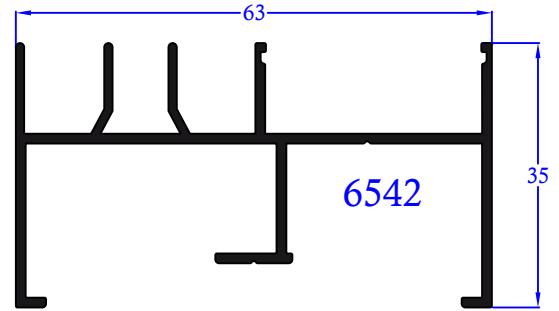
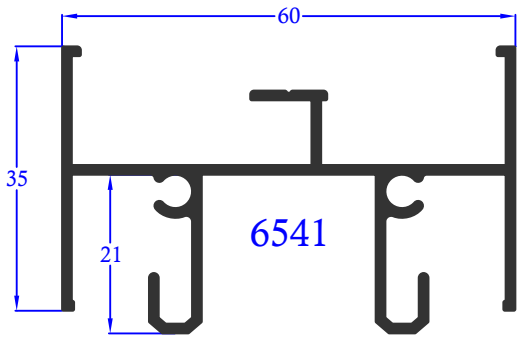



SERIE 6500 "DELFIN"

CERCOS

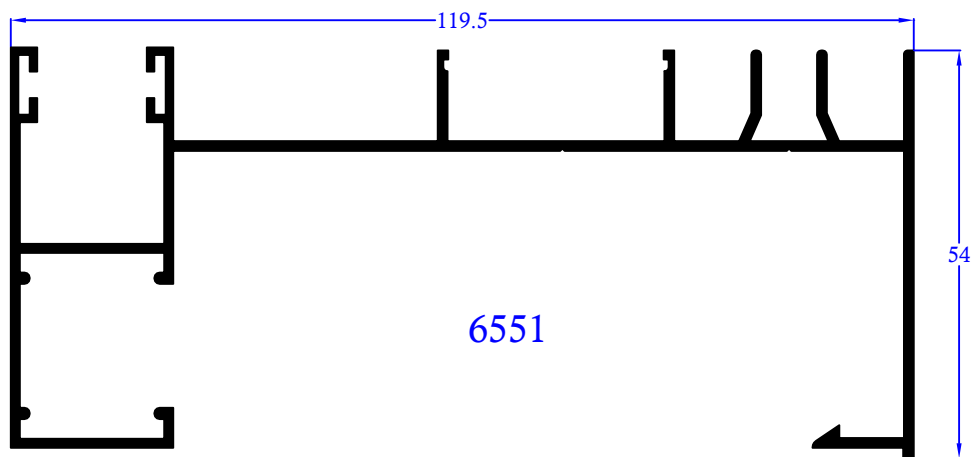
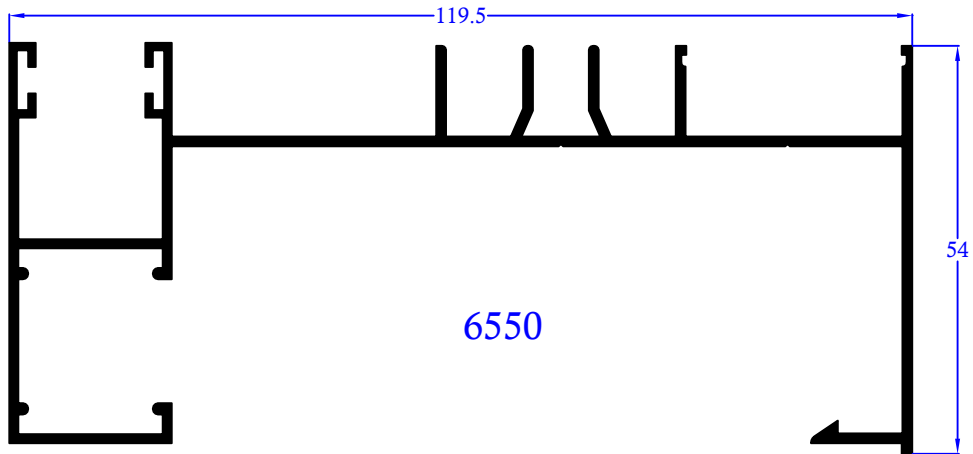



SERIE 6500 "DELFIN"

FOJAS

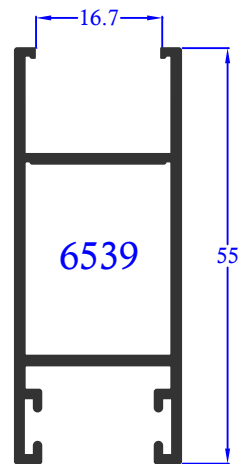
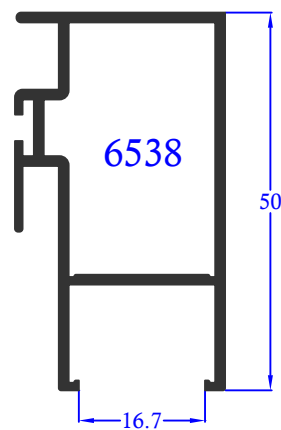
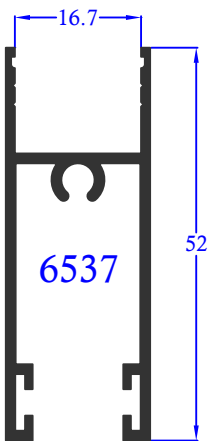
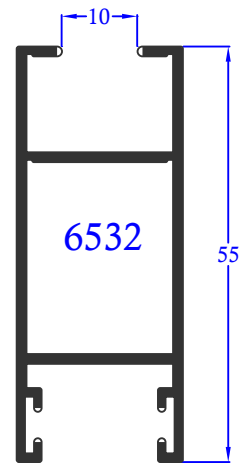
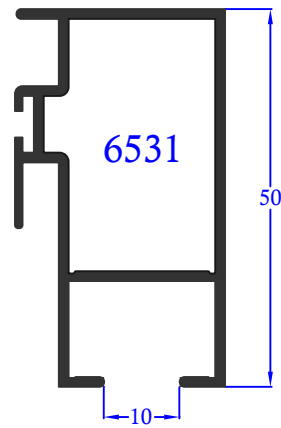
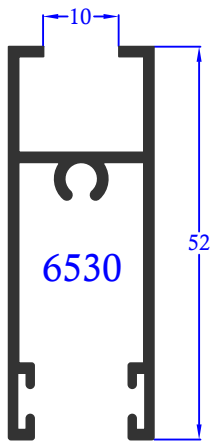
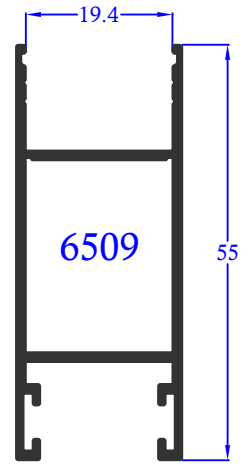
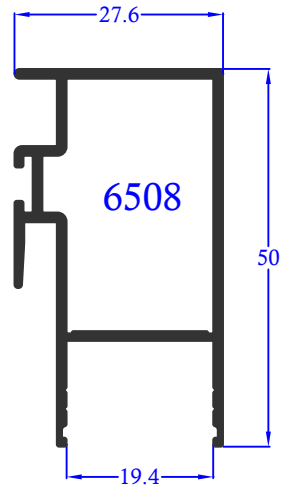
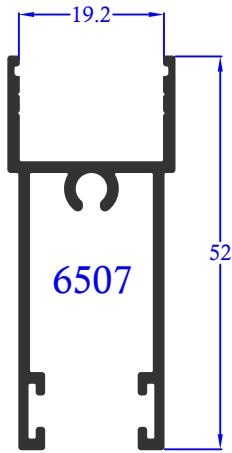



SERIE 6500 "DELFIN"

FOJAS

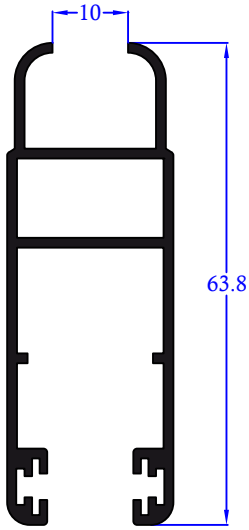

6560

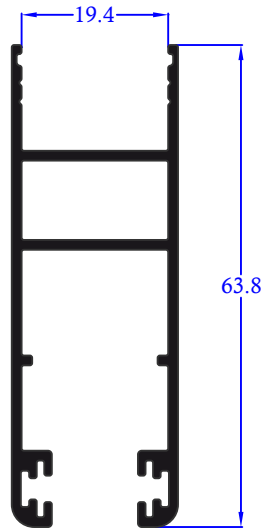

6561

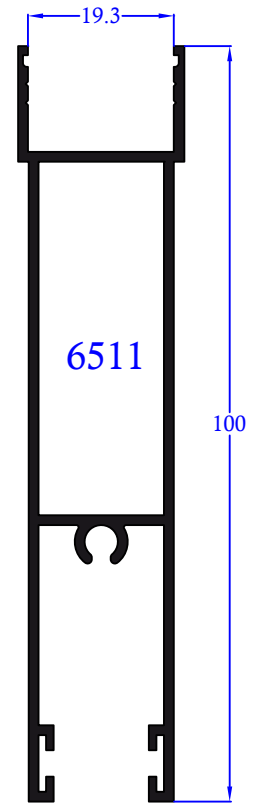

6511

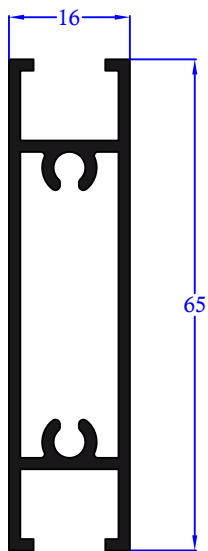

6581

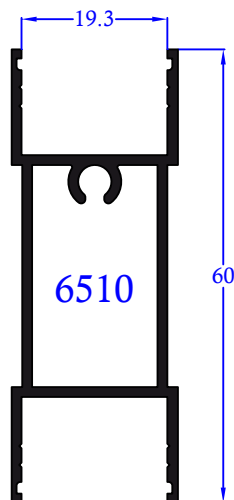

6510

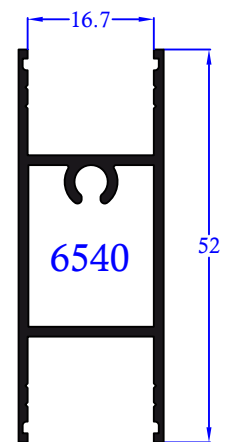

6540



SERIE 6500 "DELFIN"

COMPONENTE GENERAL

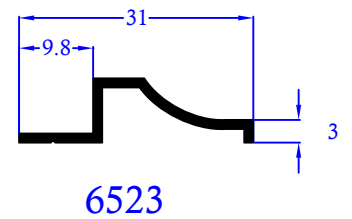
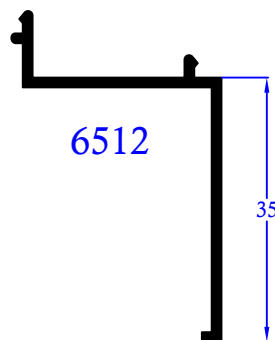
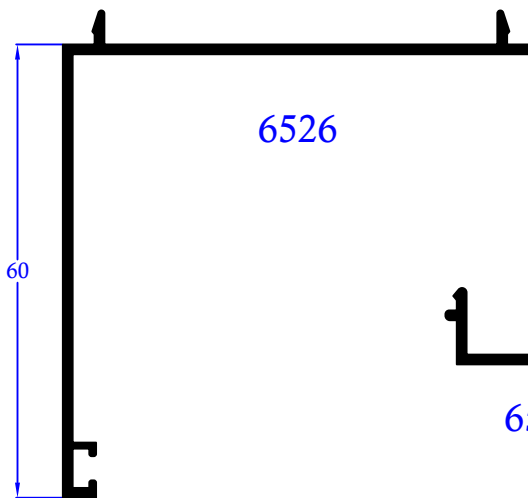
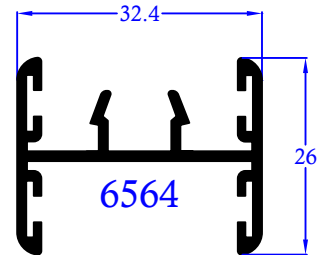
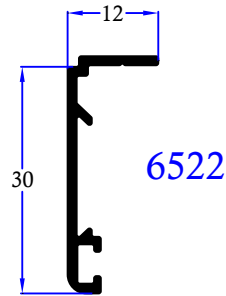
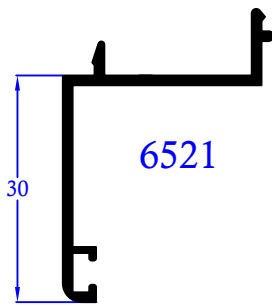
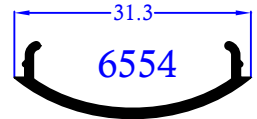
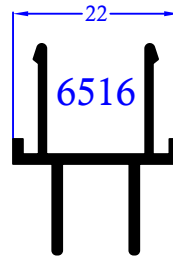
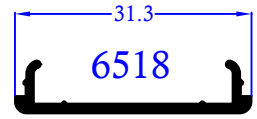
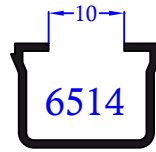
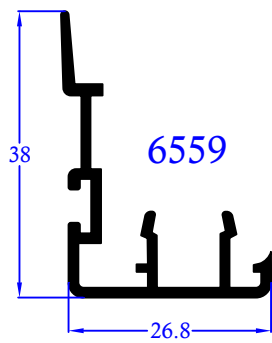



SERIE 6500 "DELFIN"

COMPONENTE GENERAL

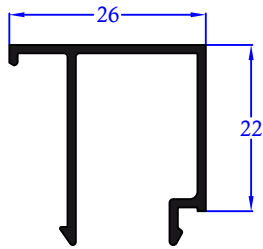

6544

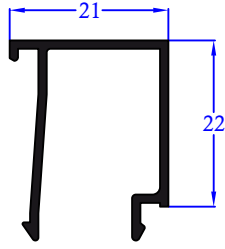

6545

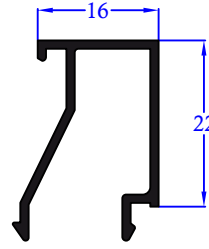

6546

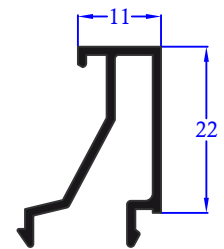

6556

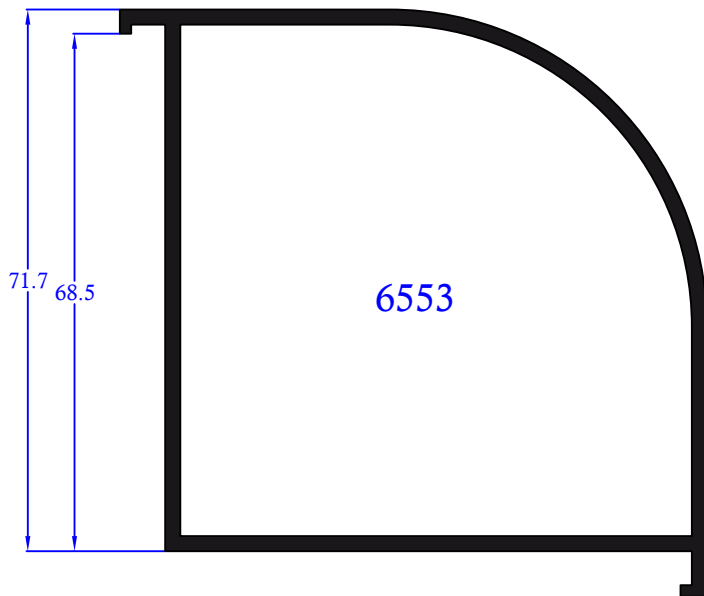

6553

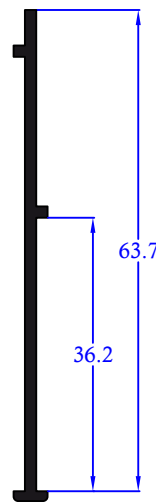

6515

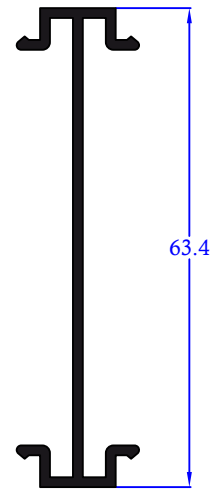

6547

CORREDERA PERIMETRAL



TABLA ORIENTATIVA DE CORTE PARA VENTANA DE DOS HOJAS

REFERENCIA	DENOMINACION	UNIDADES	MEDIDAS DE CORTE EN mm.
6567	CERCOS HORIZONTALES	2	 L
6567	CERCOS VERTICALES	2	 H
6561	HOJAS HORIZONTALES	4	 $(L/2) - 2$
6561	HOJAS VERTICALES	4	 H-68
6559	PERFIL DE ENCUENTRO CENTRAL	2	 H-68
6579	VIERTIAGUAS SUPERIOR	1	 L
6561	PARA VENTANAS DE 4 HOJAS	8	 $(L/4) + 12$

NOTA: Cuando use las tablas de corte para sus fabricados haga las comprobaciones pertinentes, ya que estas son orientativas y no absolutas

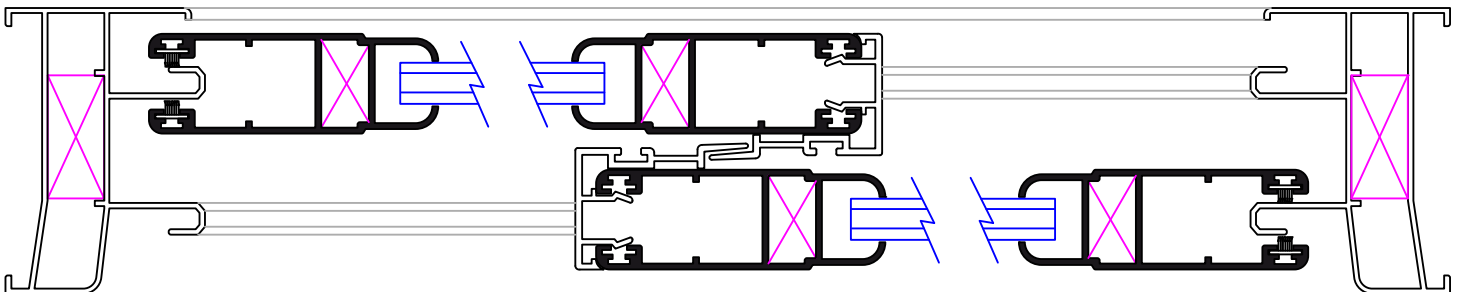
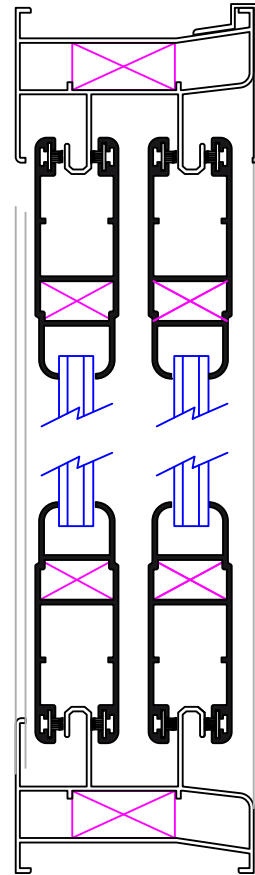
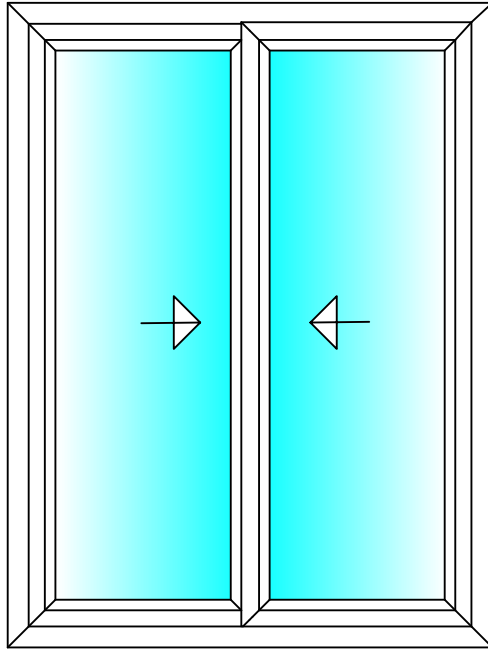

SERIE 6500 "DELFIN"

TABLA DE CORTE

SERIE 6500 CORREDERA

TABLA ORIENTATIVA DE CORTE PARA VENTANA DE DOS HOJAS

REFERENCIA	DENOMINACION	UNIDADES	MEDIDAS DE CORTE EN mm.
6541	CERCO HORIZONTAL SUPERIOR	1	<input type="text" value="L-47"/>
6543	CERCO HORIZONTAL INFERIOR	1	<input type="text" value="L-47"/>
6542	CERCOS VERTICALES LATERALES	2	<input type="text" value="H"/>
6530	HOJAS HORIZONTALES	4	<input type="text" value="L/2-18"/>
6531	HOJAS VERTICALES CENTRALES	2	<input type="text" value="H-62"/>
6532	HOJAS VERTICALES LATERALES	2	<input type="text" value="H-62"/>
6518 ó 6554	TAPETA PARA CERCO LATERAL	2	<input type="text" value="H-42"/>
6530	PARA VENTANA DE 4 HOJAS	8	<input type="text" value="L/4-5"/>

SERIE 6500 CORREDERA

TABLA ORIENTATIVA DE CORTE PARA VENTANA DE DOS HOJAS

REFERENCIA	DENOMINACION	UNIDADES	MEDIDAS DE CORTE EN mm.
6541	CERCO HORIZONTAL SUPERIOR	1	<input type="text" value="L-82"/>
6543	CERCO HORIZONTAL INFERIOR	1	<input type="text" value="L-82"/>
6550	CERCO LATERAL IZQUIERDO	1	<input type="text" value="H"/>
6551	CERCO LATERAL DERECHO	1	<input type="text" value="H"/>
6530	HOJAS HORIZONTALES	4	<input type="text" value="L/2-34"/>
6531	HOJAS VERTICALES CENTRALES	2	<input type="text" value="H-62"/>
6532	HOJAS VERTICALES LATERALES	2	<input type="text" value="H-62"/>
6518 ó 6554	TAPETA PARA CERCO LATERAL	2	<input type="text" value="H-42"/>

NOTA: Cuando use las tablas de corte para sus fabricados haga las comprobaciones pertinentes, ya que estas son orientativas y no absolutas



SERIE 6500 "DELFIN"

DETALLES

VENTANA CORREDERA DE DOS HOJAS

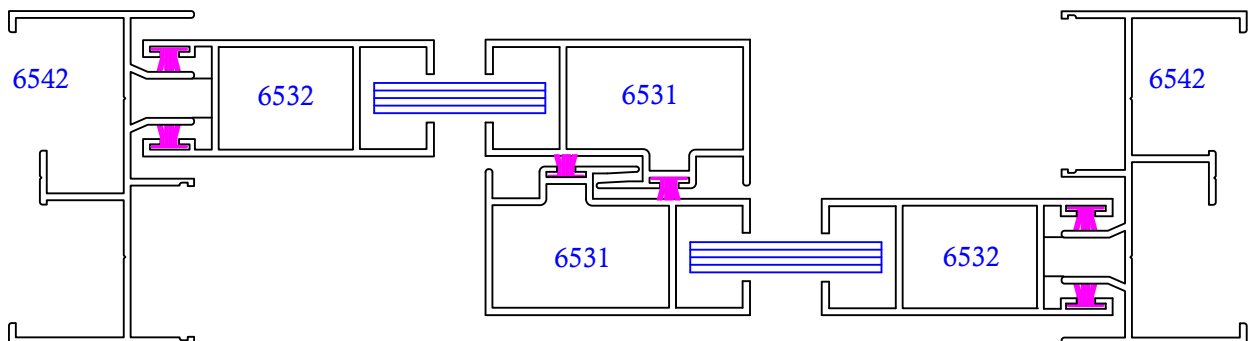
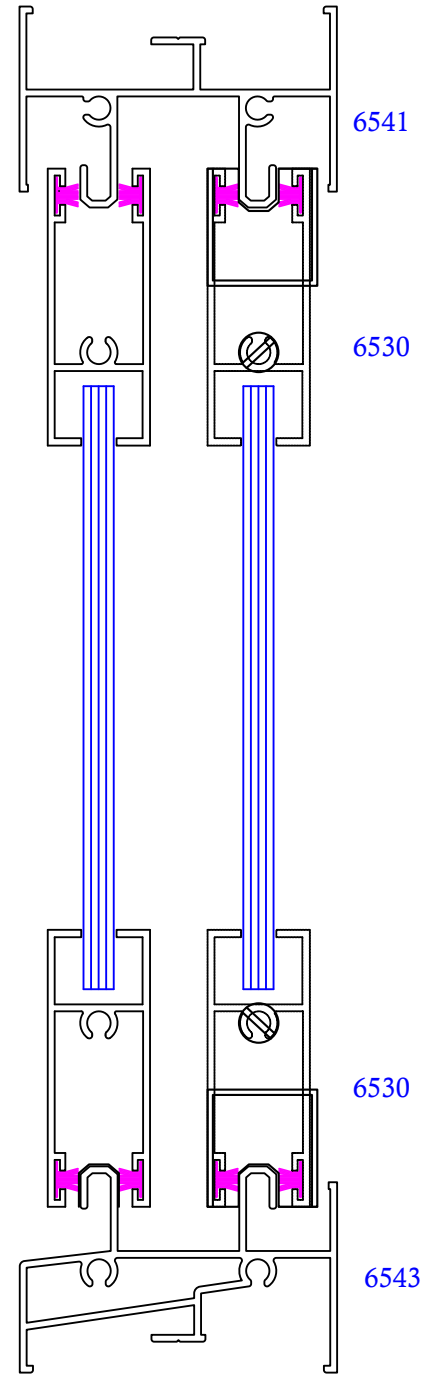
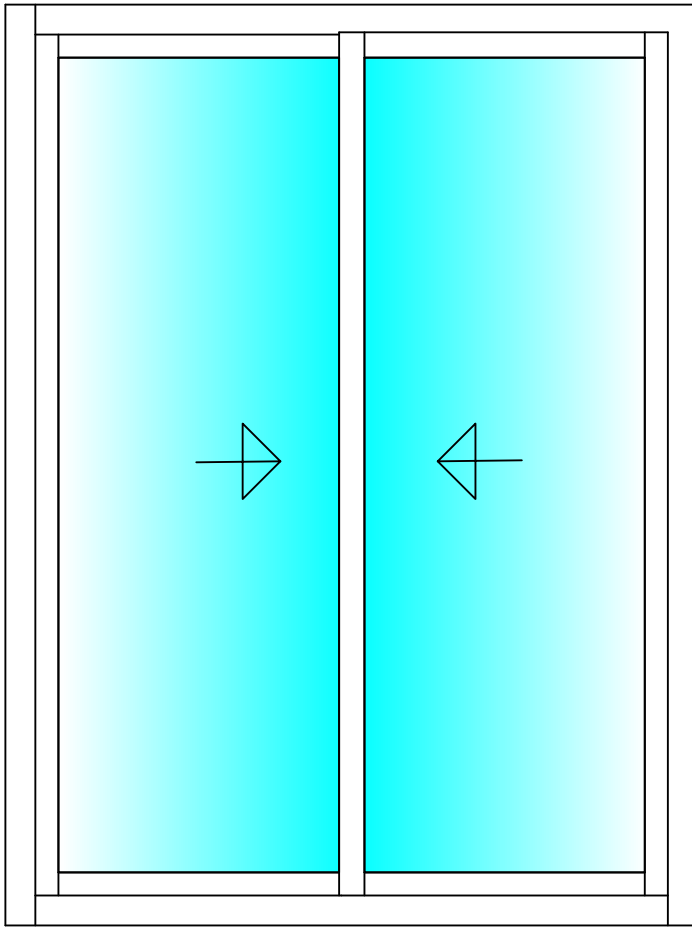



SERIE 6500 "DELFIN"

DETALLES

VENTANA CORREDERA DE DOS HOJAS

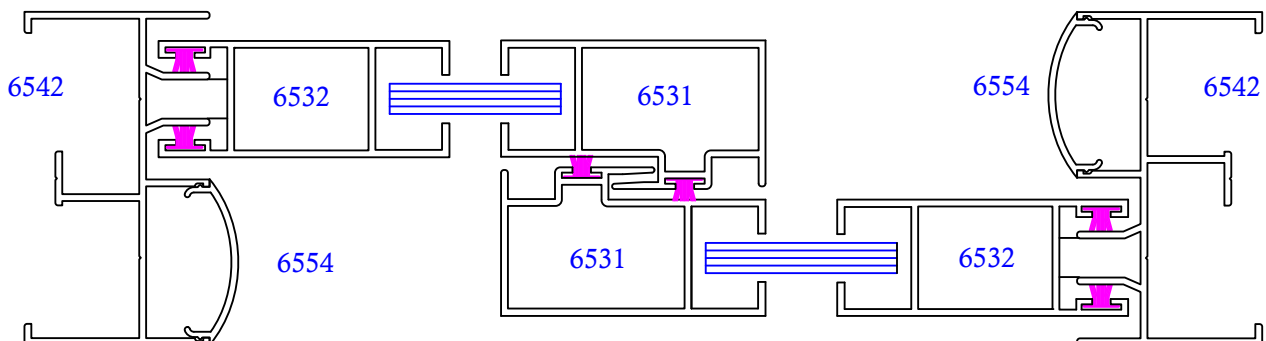
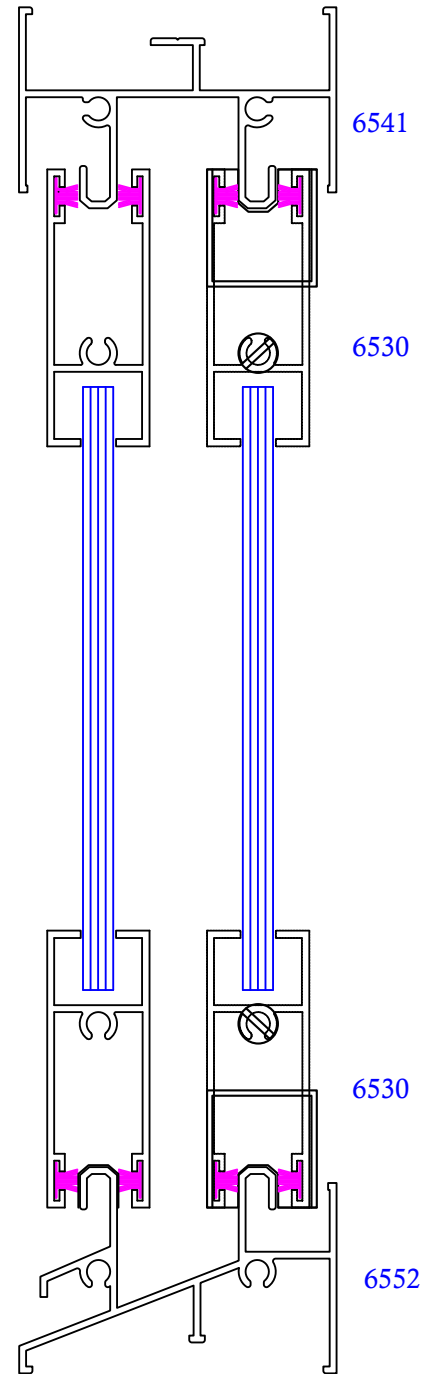
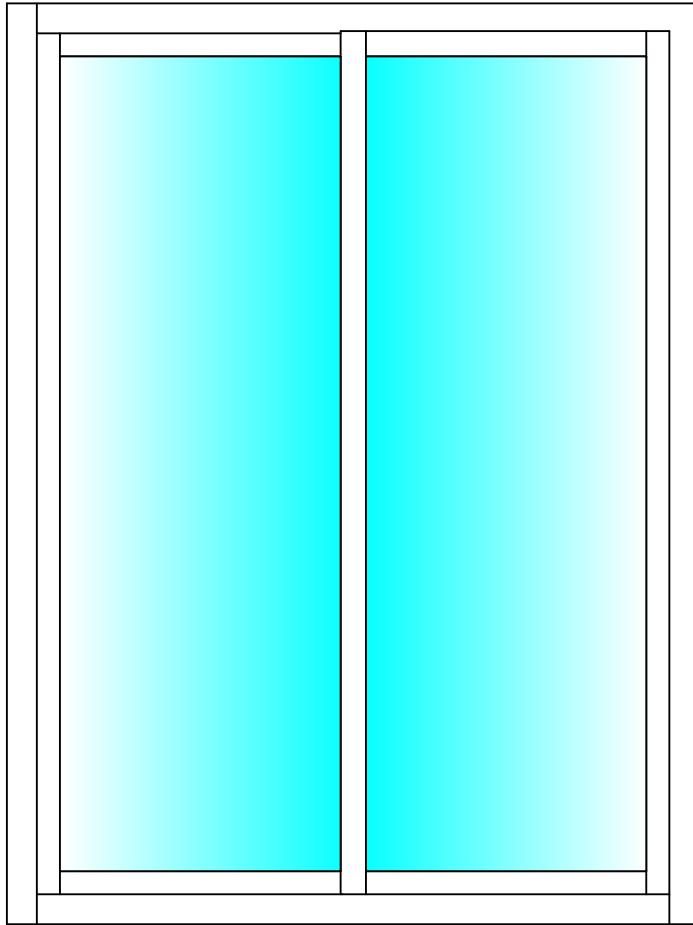



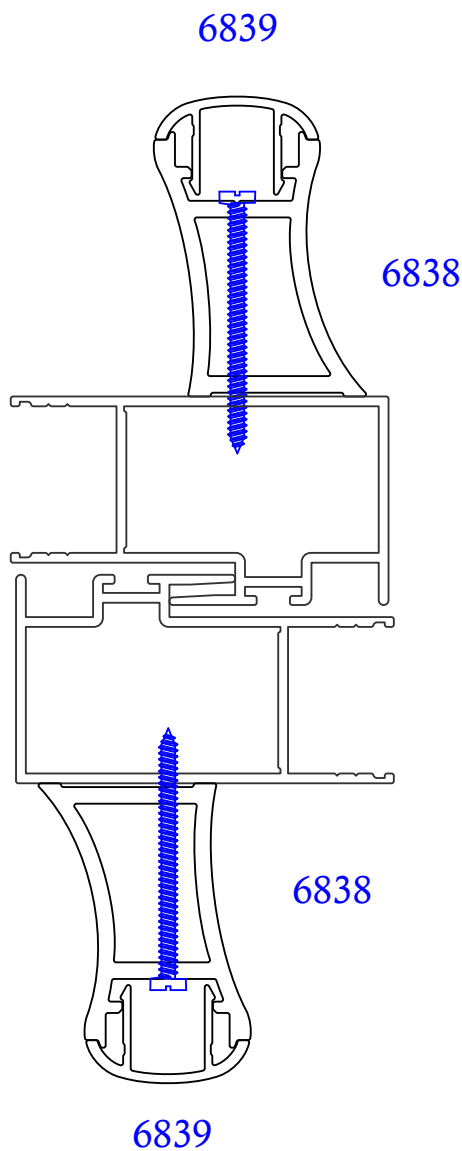



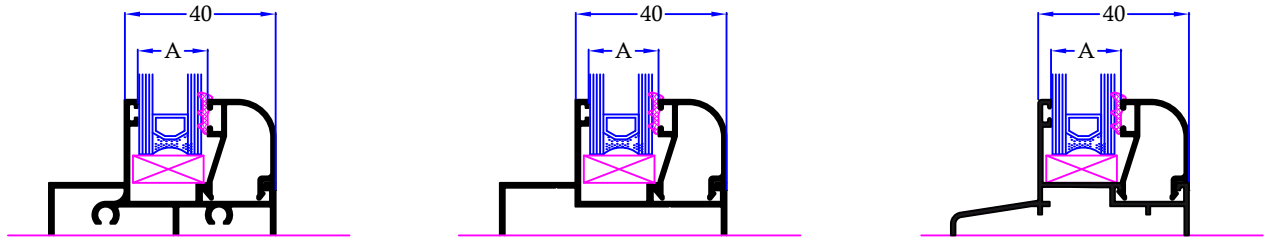



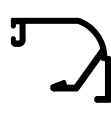

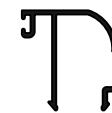

DETALLE MONTAJE REFUERZO 6838, 6839



NOTA: En alturas superiores a 1400 mm es necesario reforzar las hojas.



CERCOS FIJOS

CERCO FIJO A	REFERENCIA JUNQUILLOS							
10 mm	6544	 26	4596	 26	4524	 26	4528	 26
15 mm	6545	 21	4595	 21	4523	 21	4527	 21
20 mm	6546	 16	4594	 16	4522	 16	4526	 16
25 mm	6556	 11	4593	 11	4521	 11	4525	 11

NOTA: Cuando use estas tablas para sus fabricados haga las comprobaciones pertinentes, ya que estas son orientativas y no absolutas.