

SERIE 2500 "I.D.AL."

ABISAGRADA DE 40MM. FRIA CON JUNTA CENTRAL

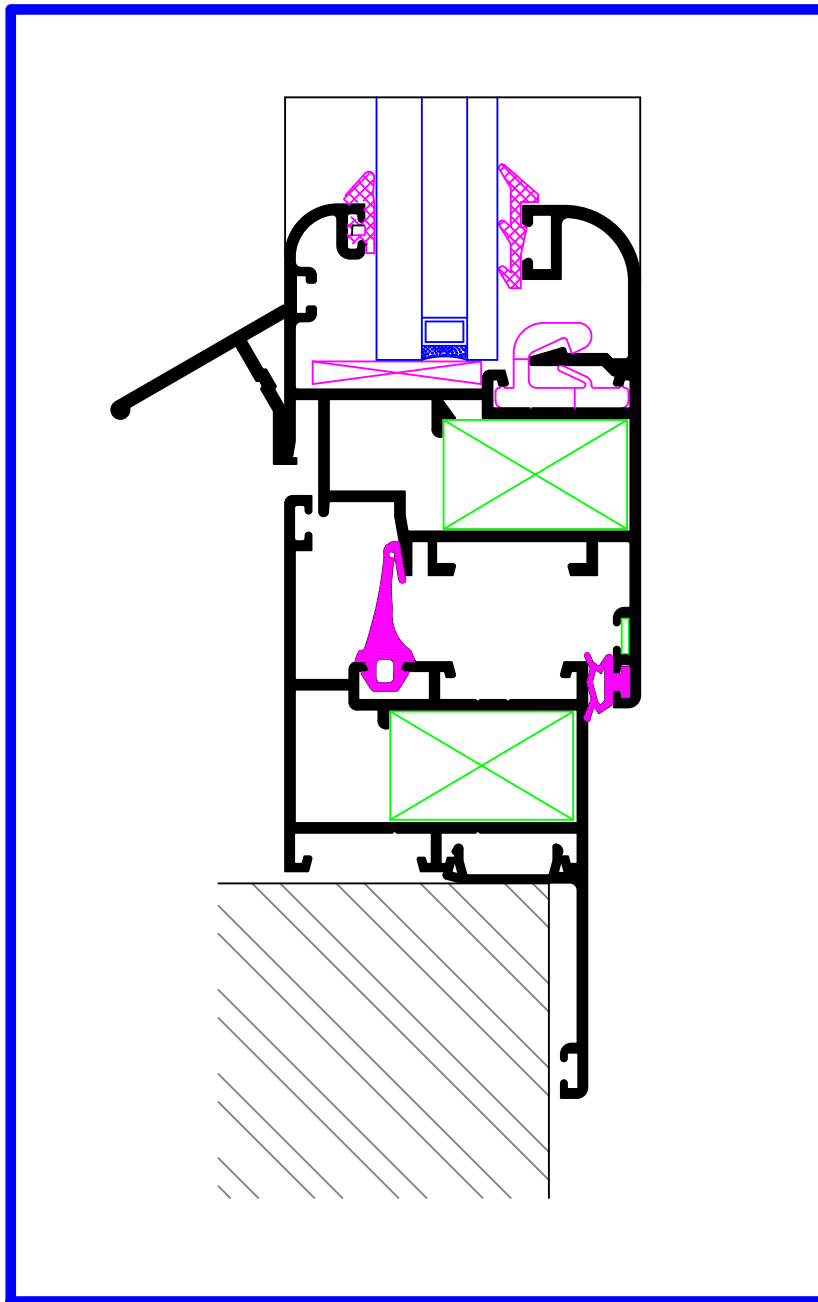

- ◆ Ventana de aluminio de 40mm. económica y versatil
- ◆ Cámara EUROPEA estándar para el herraje.
- ◆ Altura de galce de cristal de 22mm. y grosores de 4mm. hasta de 38 mm.
- ◆ Junta central de EPDM para conseguir una perfecta estanqueidad.



SERIE 2500 "I.D.AL."

RESULTADO DE ENSAYOS

RESULTADO Y CLASIFICACIÓN GENERAL DE LA MUESTRA ENSAYADA

Las conclusiones que aquí se formulan no exceden, en ningún caso, el alcance y significado que permitan establecer dichos análisis.

Las pruebas referidas a este trabajo, salvo expresa indicación, han sido realizadas sobre una muestra libremente elegida por el peticionario.

PARÁMETROS DETERMINADOS	NORMA	CLASIFICACIÓN	
		GLOBAL ²	NORMA
ENSAYO DE PERMEABILIDAD AL AIRE	UNE-EN 1026:2000	CLASE 4	UNE-EN 12207:2000
ENSAYO DE ESTANQUEIDAD AL AGUA	UNE-EN 1027:2000	CLASE 9A	UNE-EN 12208:2000
ENSAYO DE RESISTENCIA AL VIENTO	UNE-EN 12211:2000	CLASE C5	UNE-EN 12210:2000

La clasificación final de la muestra está basada en los valores y condiciones de ensayo reflejados en las doce páginas que componen este documento.

Vº Bº DEL DIRECTOR
DEL LABORATORIO

Fdo. José Morales Henares

EL JEFE DE ÁREA

Fdo. Luis García Viguera

¹ Datos suministrados por el peticionario y/o representante en obra.

² La valoración de idoneidad del producto a partir de los ensayos realizados es potestad de los técnicos competentes nombrados expresamente a tal fin por el peticionario, por ello, los valores de referencia y comentarios que Ensatec, S.L. pudiese realizar tienen únicamente carácter informativo y nunca vinculante.

³ Ensatec, S.L. dispone del cálculo de las Incertidumbres asociadas al ensayo a disposición del peticionario.

ENAC
E N S A Y O S
N.º: 288/LE634

NOTA: Ventana de 1200 x 1200 sin cajon

CERCOS

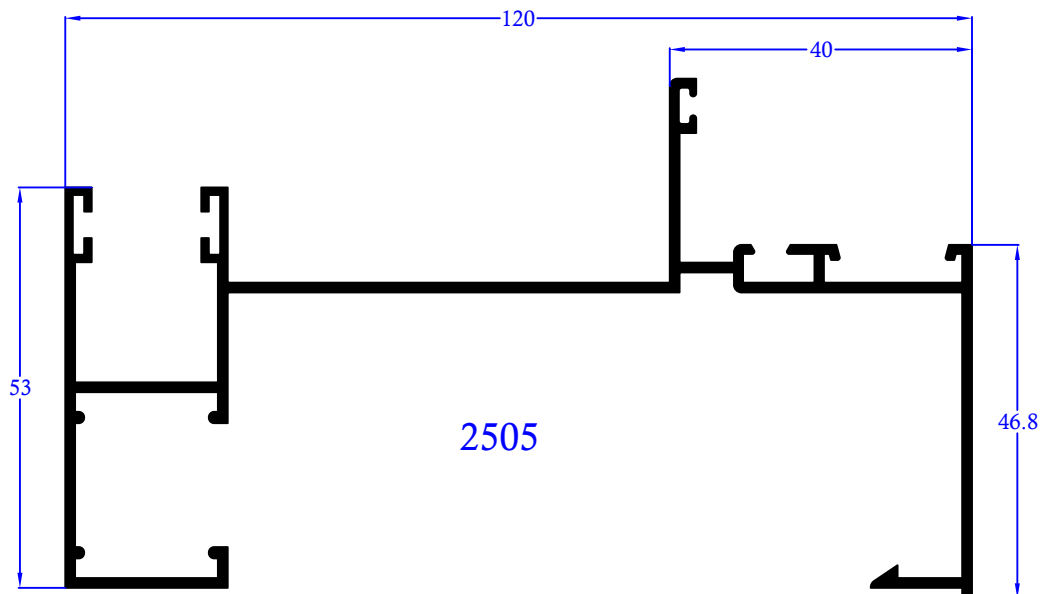
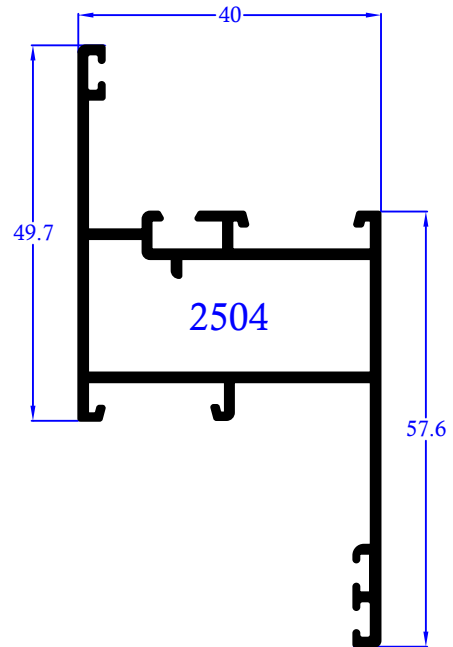
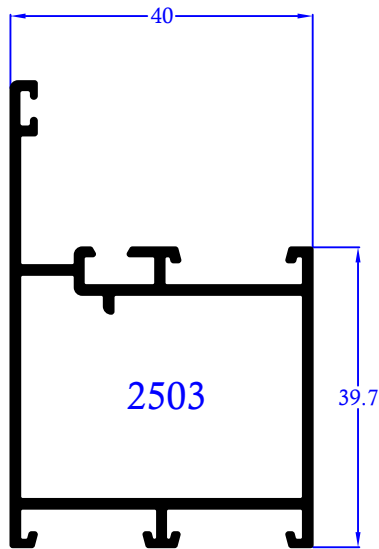
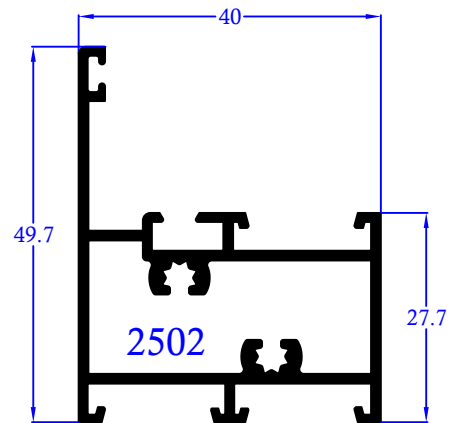
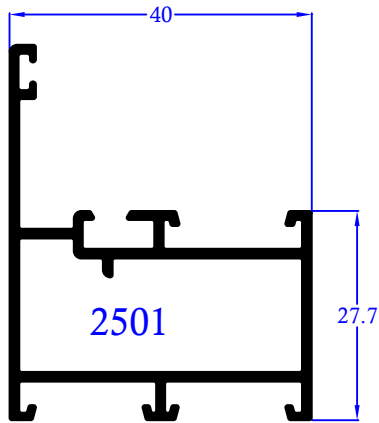

NOTA: Junquillos de las Series 4500 y 6500, pletina de cremona 2036, esquineros y uniones de la Serie-3500.



SERIE 2500 "i.D.AL."

CERCOS

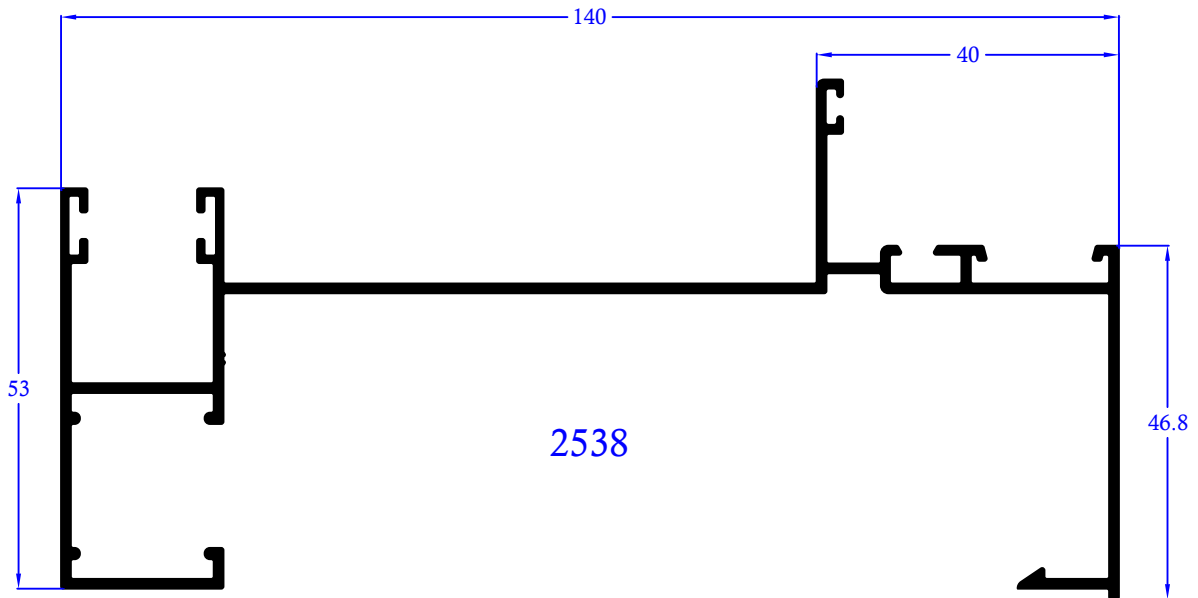
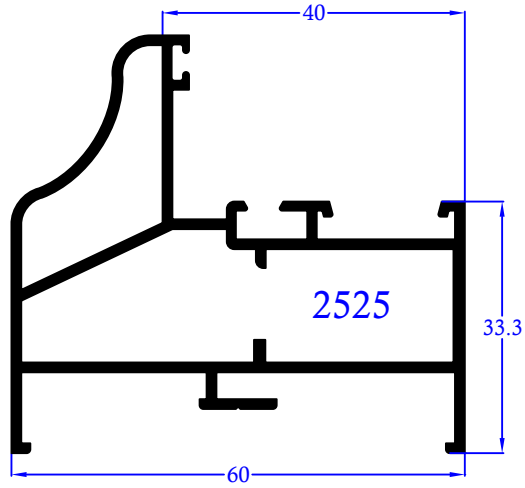



SERIE 2500 "I.D.AL."

FOJAS

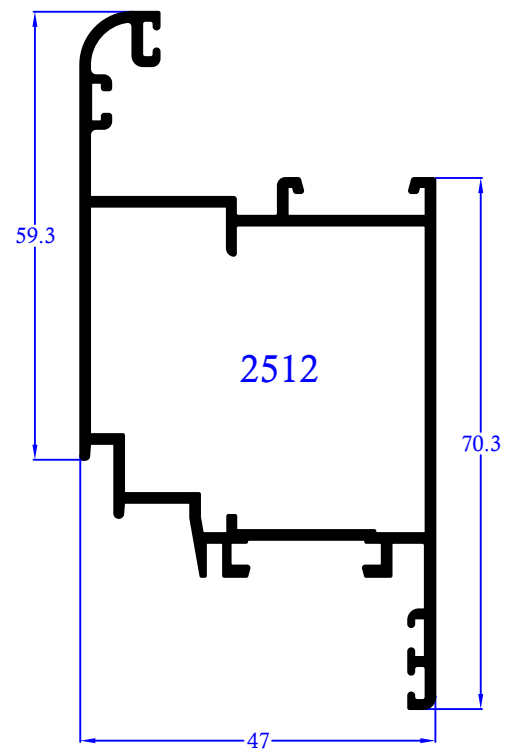
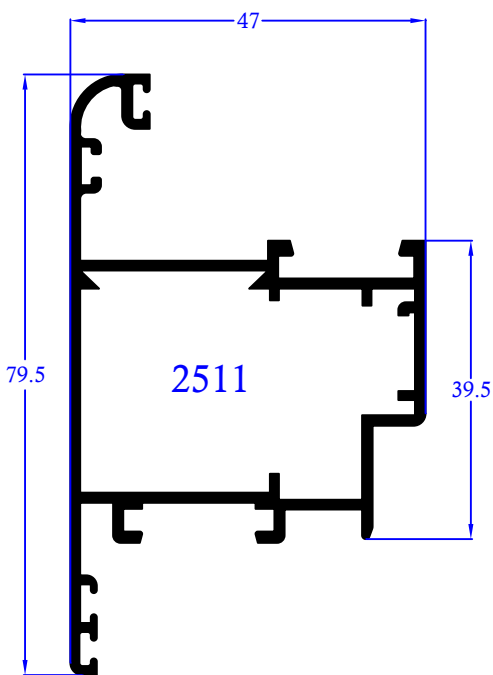
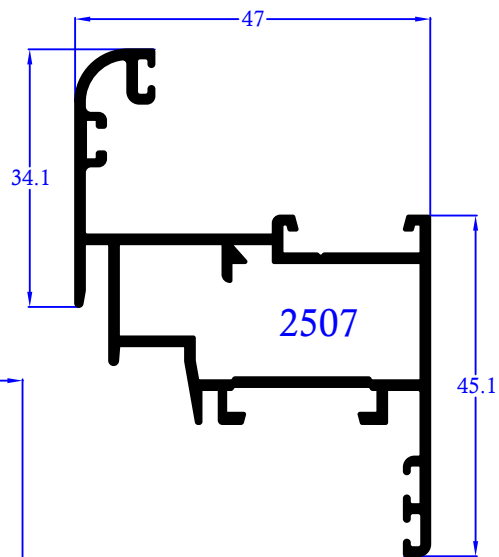
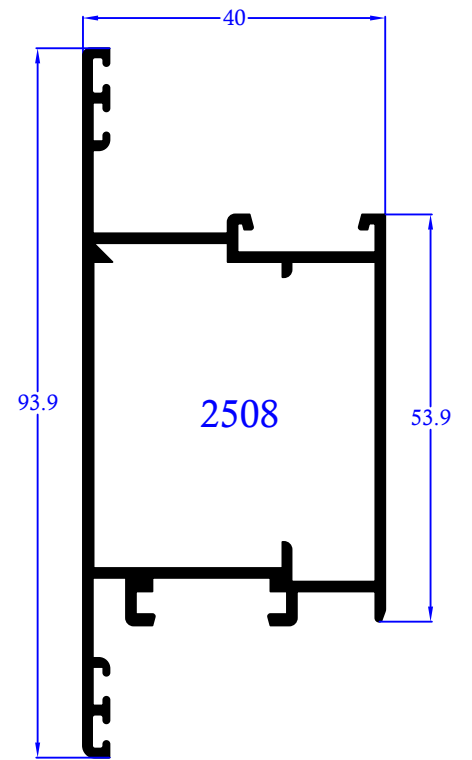
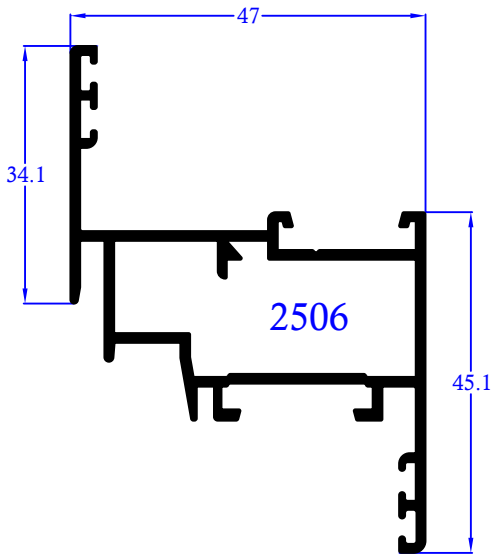



SERIE 2500 "I.D.AL."

FOJAS

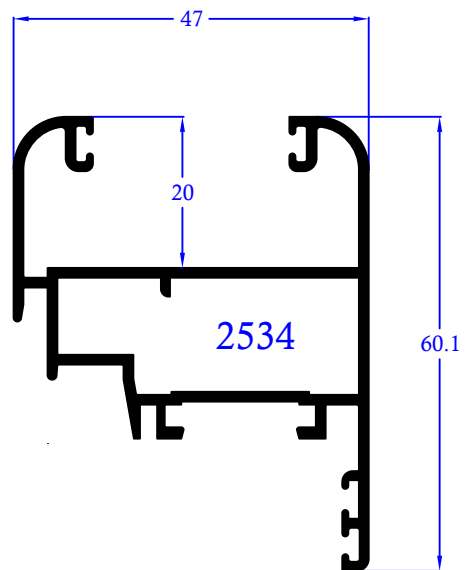
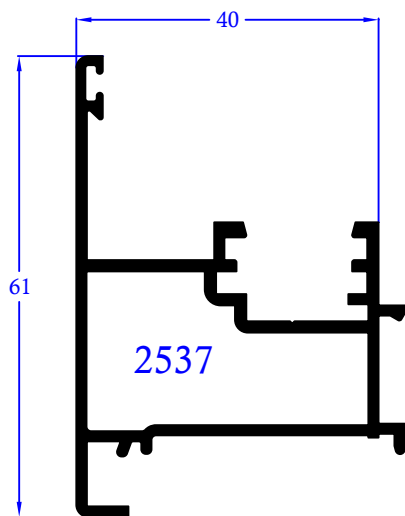
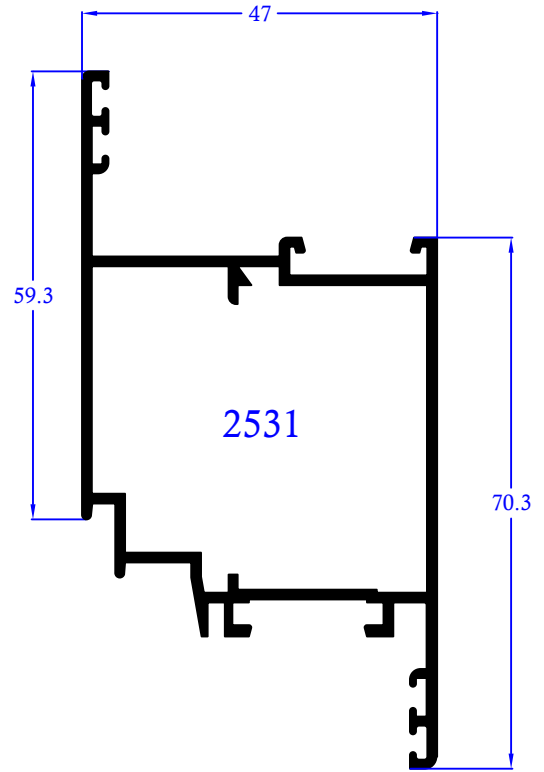
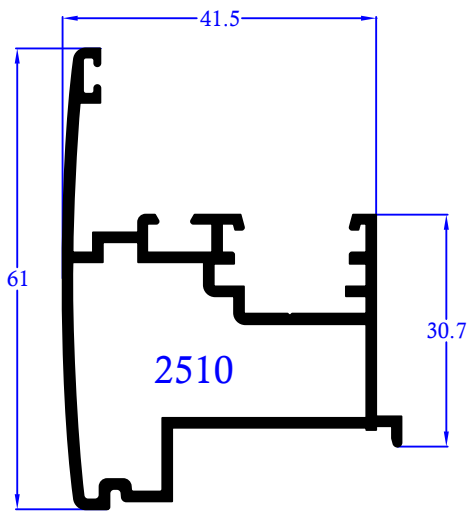

TRAVESAÑOS

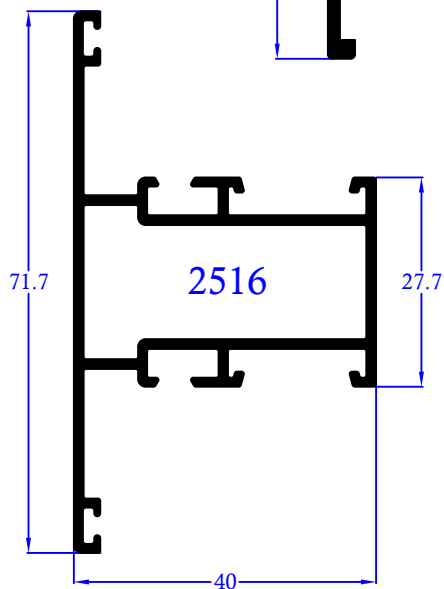
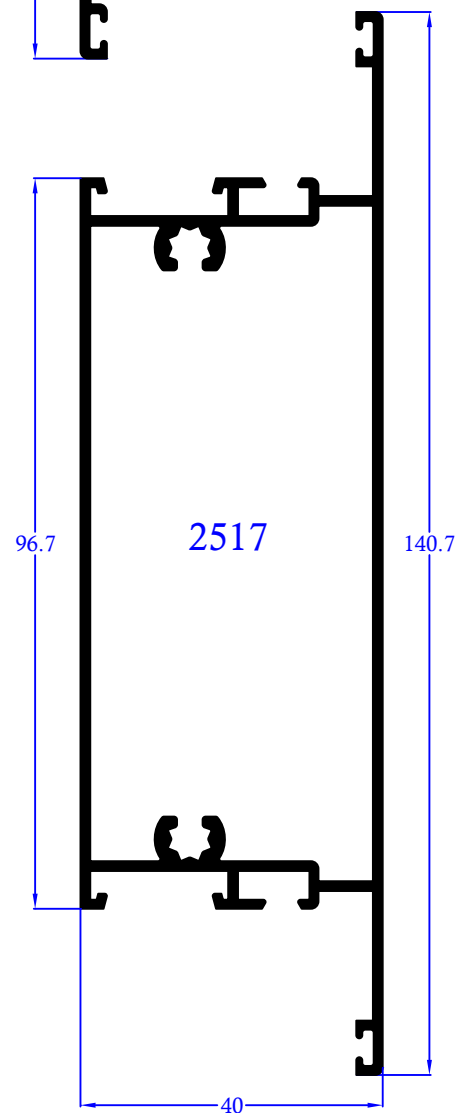
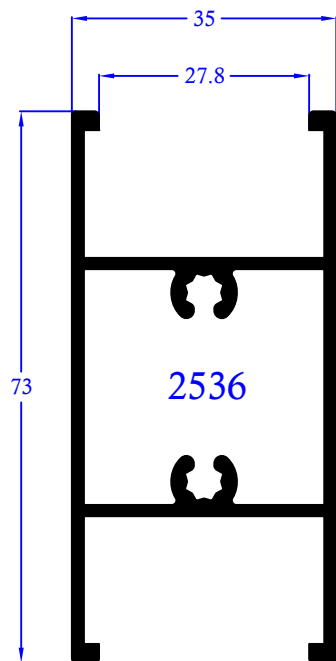
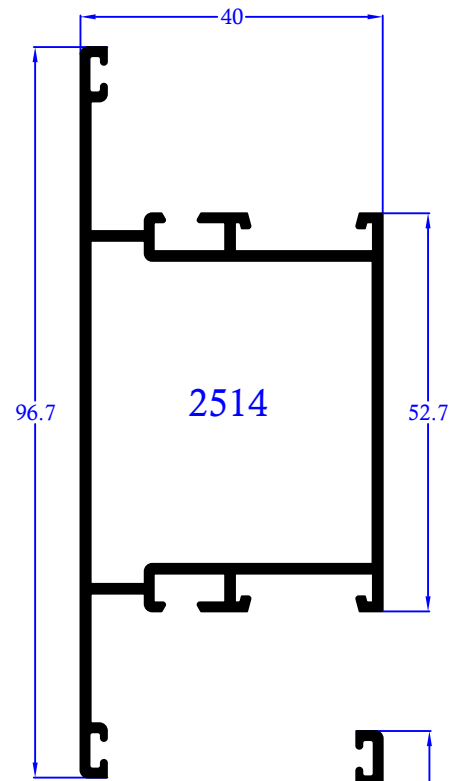
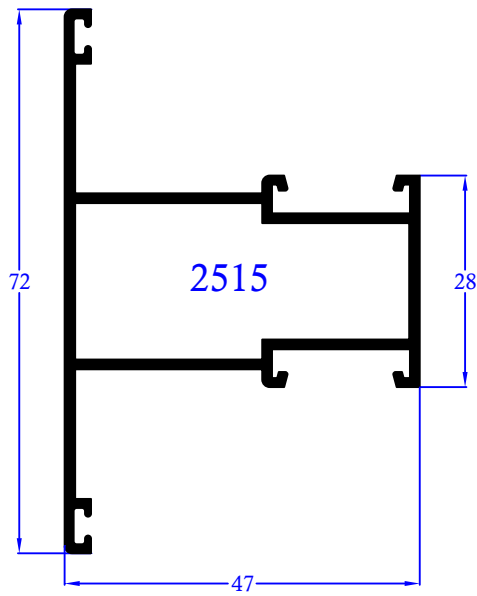



SERIE 2500 "I.D.AL."

COMPONENTE GENERAL

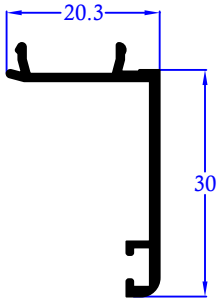

2518

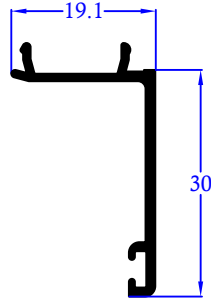

2519

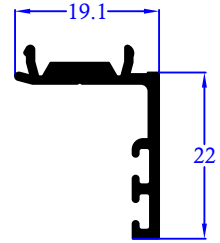

2520

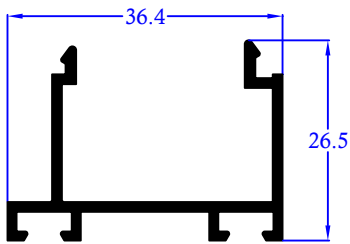

2521

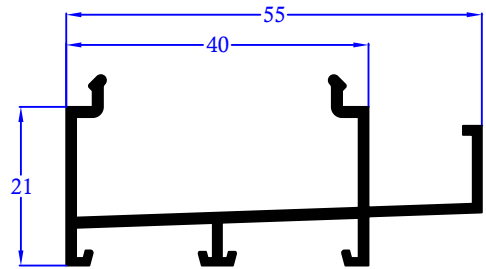

2522

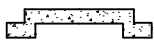

P-2524
Producto de
A.B.S. reforzado.

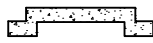

P-2539
Rollo de 250
metros



2036

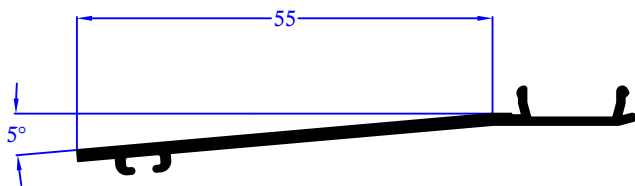

2523

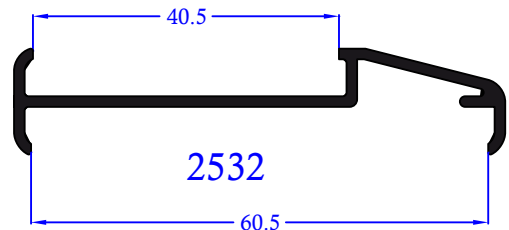

2532



SERIE 2500 "I.D.AL."

MEDIDAS DE CORTE

SERIE 2500 ABISAGRADA

TABLA ORIENTATIVA DE CORTE PARA VENTANA DE DOS HOJAS

REFERENCIA	DENOMINACION	UNIDADES	MEDIDAS DE CORTE EN mm.
2501	CERCO HORIZONTAL	2	
2501	CERCO VERTICAL	2	
2507	HOJA HORIZONTAL	4	
2507	HOJA VERTICAL	4	
2510	INVERSOR	1	
4522	JUNQUILLOS HORIZONTALES	4	
4522	JUNQUILLOS VERTICALES	4	

SERIE 2500 ABISAGRADA

TABLA ORIENTATIVA DE CORTE PARA VENTANA DE UNA HOJA

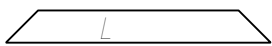
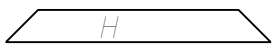
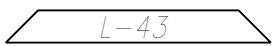
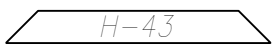
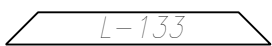
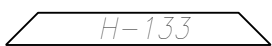
REFERENCIA	DENOMINACION	UNIDADES	MEDIDAS DE CORTE EN mm.
2501	CERCO HORIZONTAL	2	
2501	CERCO VERTICAL	2	
2507	HOJA HORIZONTAL	2	
2507	HOJA VERTICAL	2	
4522	JUNQUILLOS HORIZONTALES	2	
4522	JUNQUILLOS VERTICALES	2	



NOTA: Cuando use las tablas de corte para sus fabricados haga las comprobaciones pertinentes, ya que estas son orientativas y no absolutas

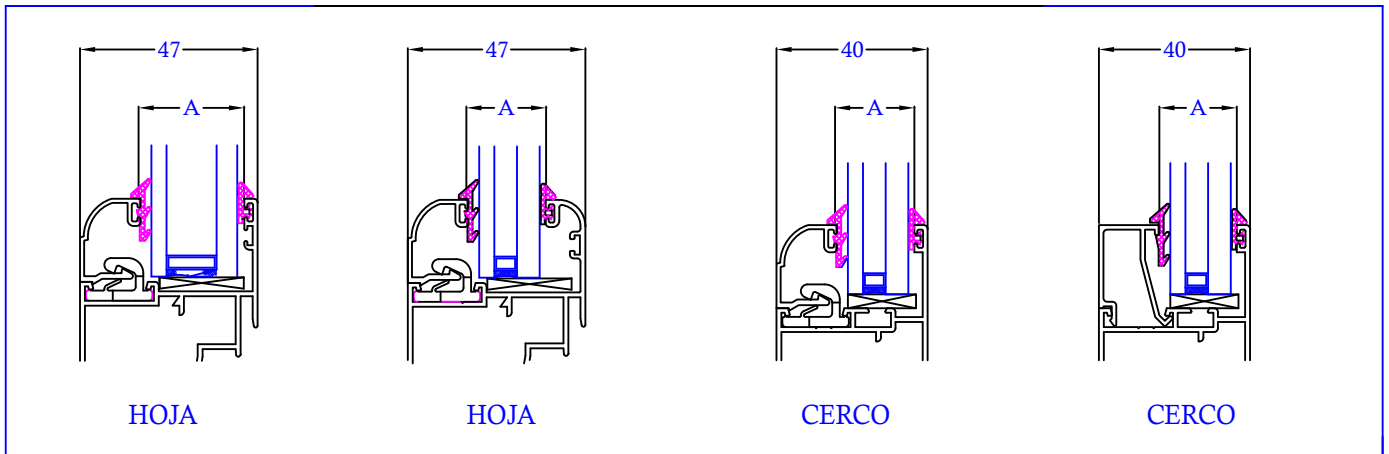

SERIE 2500 "I.D.AL."

ACRISTALAMIENTO

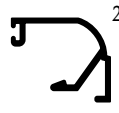

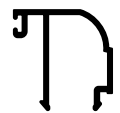
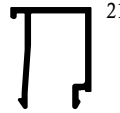
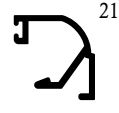
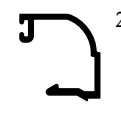
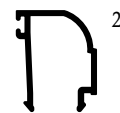
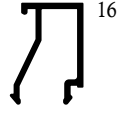
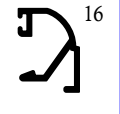
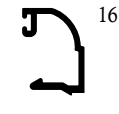
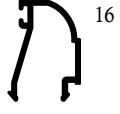
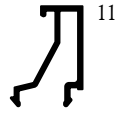
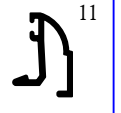
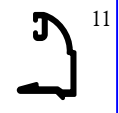
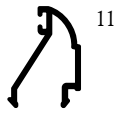
HOJAS EN RECTO A	CERCOS Y HOJAS CURVAS A	REFERENCIA JUNQUILLOS											
17 mm	10 mm	6544		26	4596		26	4524		26	4528		26
22 mm	15 mm	6545		21	4595		21	4523		21	4527		21
27 mm	20 mm	6546		16	4594		16	4522		16	4526		16
32 mm	25 mm	6556		11	4593		11	4521		11	4525		11

DETALLES

Abisagrada de dos hojas

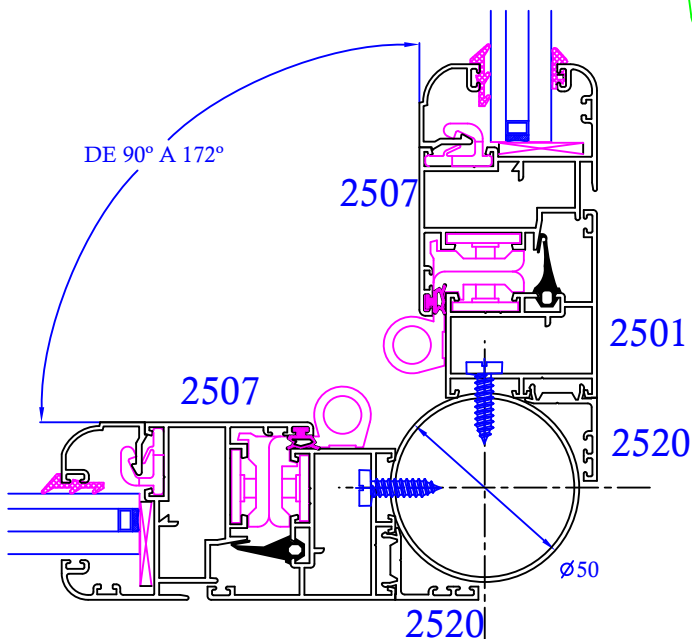
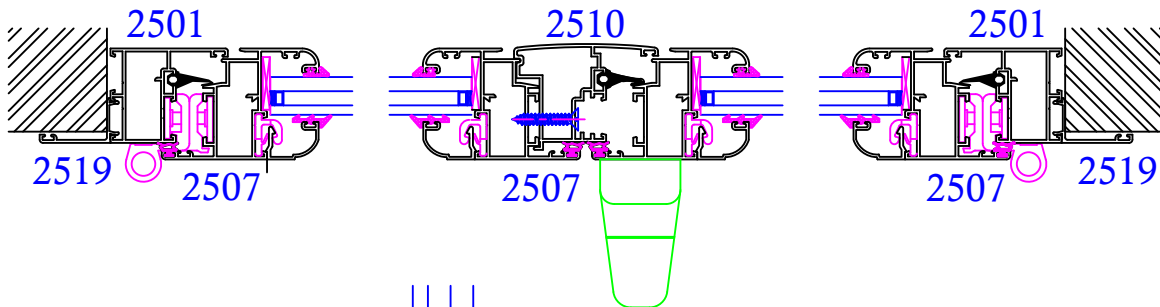
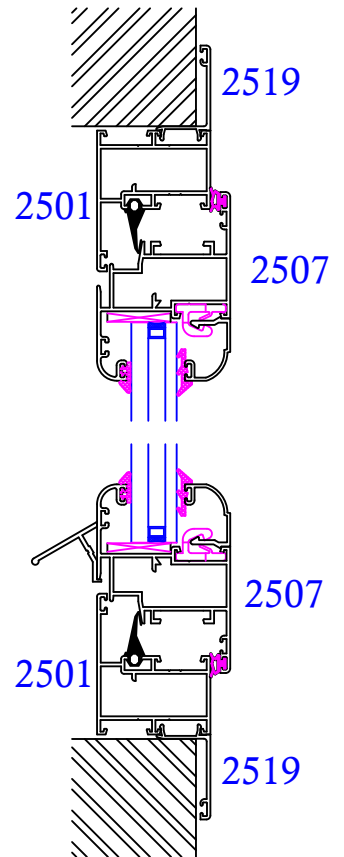
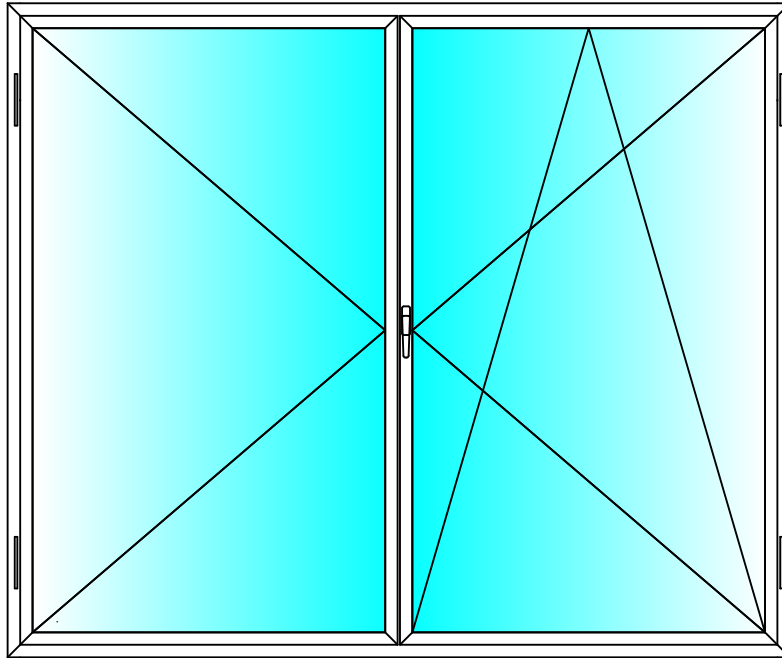

Angulo con tubo de \varnothing 50mm.

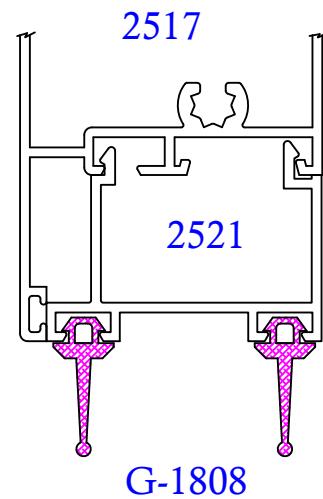

Remate de puerta

ABISAGRADA DE DOS HOJAS CON CERCO REDONDEADO

